

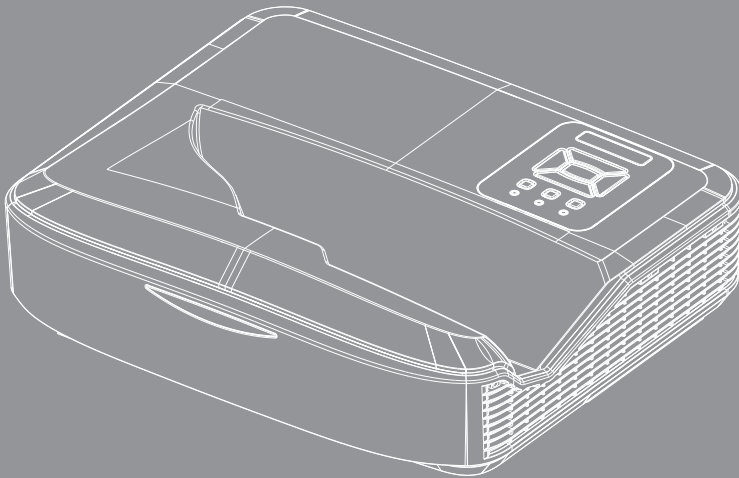

DLP® Projector



User manual





Table of Contents

Table of Contents	2	Appendices	50
Usage Notice	3	<i>Installing and Cleaning the Optional Dust Filter</i>	50
<i>Safety Information</i>	3	<i>Compatibility Modes</i>	51
<i>Precautions</i>	5	VGA Analog	51
Introduction	7	HDMI Digital.....	53
<i>Package Overview</i>	7	<i>Regulation & Safety Notices</i>	55
<i>Product Overview</i>	8	<i>Ceiling Mount Installation</i>	57
<i>Main Unit</i>	8		
<i>Control Panel</i>	9		
<i>Input/Output Connections</i>	10		
<i>Remote Control</i>	11		
Installation	12		
<i>Connecting the Projector</i>	12		
<i>Connect to Computer/Notebook</i>	12		
<i>Connect to Video Sources</i>	13		
<i>Powering the Projector On / Off</i>	14		
<i>Powering On the Projector</i>	14		
<i>Powering Off the Projector</i>	15		
<i>Warning Indicator</i>	15		
<i>Adjusting the Projected Image</i>	16		
<i>Adjusting the Projector's Height</i>	16		
<i>Adjusting the Projector's Focus</i>	17		
<i>Adjusting Projection Image Size (Diagonal)</i>	18		
User Controls	24		
<i>Control Panel & Remote Control</i>	24		
<i>Control Panel</i>	24		
<i>Remote Control</i>	25		
<i>IR Remote codes</i>	27		
<i>Structure</i>	28		
<i>On-screen Display Menus</i>	28		
<i>How to operate</i>	31		
<i>Picture</i>	32		
<i>Screen</i>	34		
<i>Setting</i>	37		
<i>Volume</i>	39		
<i>Option</i>	40		
<i>3D</i>	43		
<i>LAN</i>	44		

Usage Notice

Safety Information

	The lightning flash with arrow head within an equilateral triangle is intended to alert the user to the presence of uninsulated "dangerous voltage" within the product's enclosure that may be of sufficient magnitude to constitute a risk of electric shock to persons.
	The exclamation point within an equilateral triangle is intended to alert the user to the presence of important operating and maintenance (servicing) instructions in the literature accompanying the appliance.

WARNING: TO REDUCE THE RISK OF FIRE OR ELECTRIC SHOCK, DO NOT EXPOSE THIS APPLIANCE TO RAIN OR MOISTURE. DANGEROUS HIGH VOLTAGES ARE PRESENT INSIDE THE ENCLOSURE. DO NOT OPEN THE CABINET. REFER SERVICING TO QUALIFIED PERSONNEL ONLY.

Class B emissions limits

This Class B digital apparatus meets all requirements of the Canadian Interference-Causing Equipment Regulations.

Important Safety Instruction

1. Do not block any ventilation openings. To ensure reliable operation of the projector and to protect from over heating, it is recommended to install the projector in a location that does not block ventilation. As an example, do not place the projector on a crowded coffee table, sofa, bed, etc. Do not put the projector in an enclosure such as a book case or a cabinet that restricts air flow.
2. Do not use the projector near water or moisture. To reduce the risk of fire and/or electric shock, do not expose the projector to rain or moisture.
3. Do not install near heat sources such as radiators, heaters, stoves or any other apparatus such as amplifiers that emits heat.
4. Clean only with dry cloth.
5. Only use attachments/accessories specified by the manufacturer.
6. Do not use the unit if it has been physically damaged or abused.
Physical damage/abuse would be (but not limited to):
 - Unit has been dropped.
 - Power supply cord or plug has been damaged.
 - Liquid has been spilled on to the projector.
 - Projector has been exposed to rain or moisture.
 - Something has fallen in the projector or something is loose inside.Do not attempt to service the unit yourself. Opening or removing covers may expose you to dangerous voltages or other hazards.
7. Do not let objects or liquids enter the projector. They may touch dangerous voltage points and short out parts that could result in fire or electric shock.
8. See projector enclosure for safety related markings.
9. The unit should only be repaired by appropriate service personnel.

Usage Notice

Laser Radiation Safety Information

- This product is classified as CLASS 1 LASER PRODUCT - RISK GROUP 2 of IEC 60825-1 : 2014
- This Product is classified as Class 3R of IEC 60825-1:2007 and also complies with 21 CFR 1040.10 and 1040.11 except for deviations pursuant to Laser Notice No.50, dated June 24, 2007.



- As with any bright source, do not stare into the direct beam, RG2 IEC 62471-5:2015



- To describe the location of fixed warning label
- CLASS 3R LASER PRODUCT-AVOID DIRECT EYE EXPOSURE
- When turning on the projector, make sure no one within projection range is looking at the lens.
- Keep any items (magnifying glass etc.) out of the light path of the projector. The light path being projected from the lens is extensive, therefore any kind of abnormal objects that can redirect light coming out of the lens, can cause an unpredictable outcome such as a fire or injury to the eyes.
- Any operation or adjustment not specifically instructed by the user's guide creates the risk of hazardous laser radiation exposure.
- Do not open or disassemble the projector as this may cause damage by the exposure of laser radiation.
- Do not stare into beam when the projector is on. The bright light may result in permanent eye damage.
- Without following the control, adjustment or operation procedure may cause damage by the exposure of laser radiation

Usage Notice

Precautions



Please follow all warnings, precautions and maintenance as recommended in this user's guide.

- Warning- Do not look into the projector's lens when the lamp is on. The bright light may hurt and damage your eyes.
- Warning- To reduce the risk of fire or electric shock, do not expose this projector to rain or moisture.
- Warning- Please do not open or disassemble the projector as this may cause electric shock.

Usage Notice

Do:

- ❖ Turn off and unplug the power plug from the AC outlet before cleaning the product.
- ❖ Use a soft dry cloth with mild detergent to clean the display housing.
- ❖ Disconnect the power plug from AC outlet if the product is not being used for a long period of time.

Do not:

- ❖ Block the slots and openings on the unit provided for ventilation.
- ❖ Use abrasive cleaners, waxes or solvents to clean the unit.
- ❖ Do not clean the lens during full operation, otherwise it will cause coating loss or scratches on the lens surface. Optoma is entitled to reject such warranty.
- ❖ Use under the following conditions:
 - In extremely hot, cold or humid environments.
 - ▶ Sea level to 6000 feet
Extremely hot: > 35°C
Extremely cool: < 5°C
 - ▶ 6000 feet above
Extremely hot: > 30°C
Extremely cool: < 5°C
 - ▶ Extremely humid: > 70% R.H. (Relative Humidity)
 - In areas susceptible to excessive dust and dirt.
 - Near any appliance generating a strong magnetic field.
 - In direct sunlight.

Package Overview

Unpack and inspect the box contents to ensure all parts listed below are in the box. If something is missing, please contact your nearest customer service center.

Standard Accessories

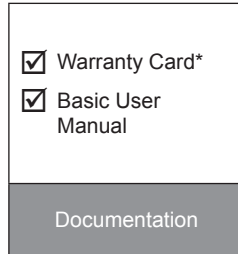
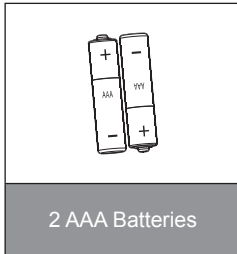
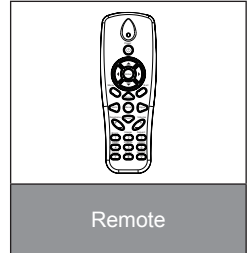
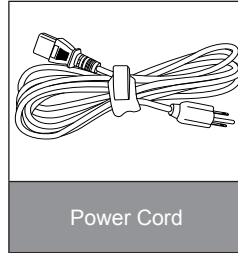
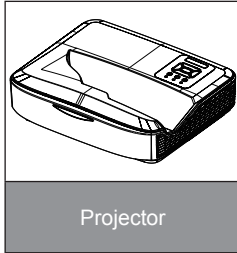

- ❖ Optional accessories vary depending on model, specification and region.
- ❖ For other laser curtain accessories, please refer to the laser curtain user manual.
- ❖ *For European warranty information please visit www.optomaeu-rope.com

Optional Accessories

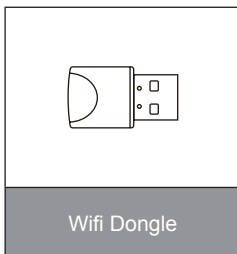
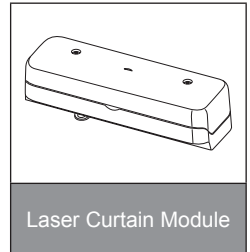
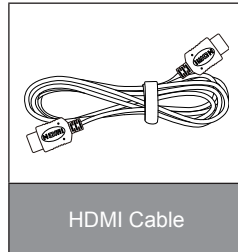
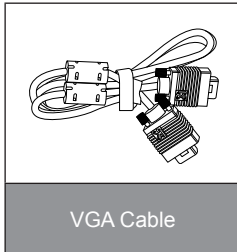

Introduction

Product Overview

Main Unit

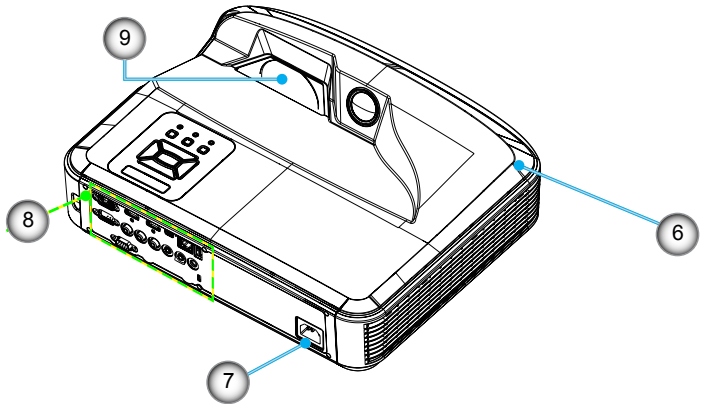
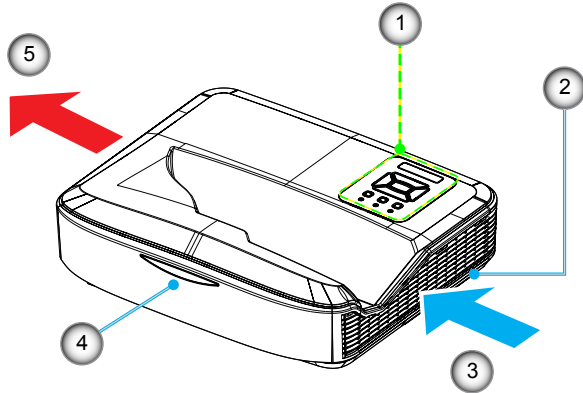

- ❖ The interface is subject to model's specifications.
- ❖ Do not block projector in/out air vents and keep a minimum 30cm distance.

- | | |
|-------------------------|-------------------------------|
| 1. Control Panel | 6. Speaker |
| 2. Focus Switch | 7. Power Socket |
| 3. Ventilation (inlet) | 8. Input / Output Connections |
| 4. IR Receiver | 9. Lens |
| 5. Ventilation (outlet) | |

Control Panel

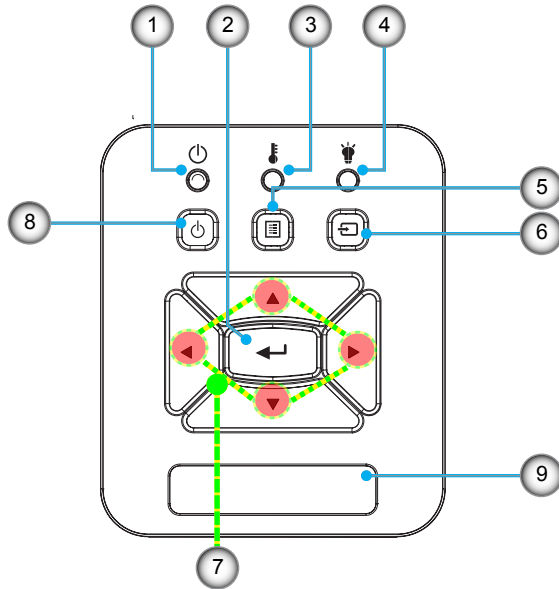

1. Power LED
2. Enter
3. Temp LED
4. Lamp LED
5. Menu
6. Input
7. Four Directional Select Keys
8. Power/Standby button
9. IR Receiver

Introduction

Input/Output Connections

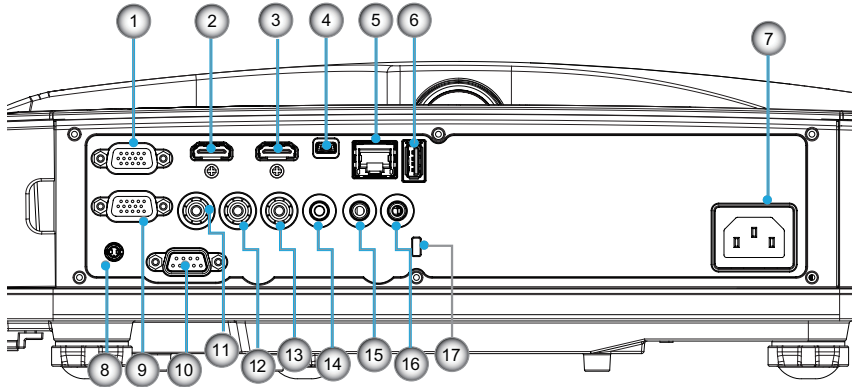

❖ The interface is subject to model's specifications.



❖ Monitor loop through only support in VGA1-In/YPbPr.

1. VGA1-In/YPbPr Connector
(PC Analog Signal/Component Video Input/HDTV/YPbPr)
2. HDMI2 Input Connector
3. HDMI1 Input Connector
4. USB Connector (Connect to PC for Remote Mouse function)
5. RJ45 connector
6. USB Type A Connector
7. Power Socket
8. Interactive connector (3.5mm mini-jack, depending on Model)
9. VGA-Out/VGA2-In Connector
10. RS-232 Connector (9-pin DIN Type)
11. Composite Video Input Connector
12. Composite Audio Input (right) Connector
13. Composite Audio Input (left) Connector
14. Audio Output Connector (3.5mm mini jack)
15. Audio Input Connector (3.5mm mini jack)
16. Audio Input Connector (microphone)
17. Kensington™ Lock Port

Remote Control

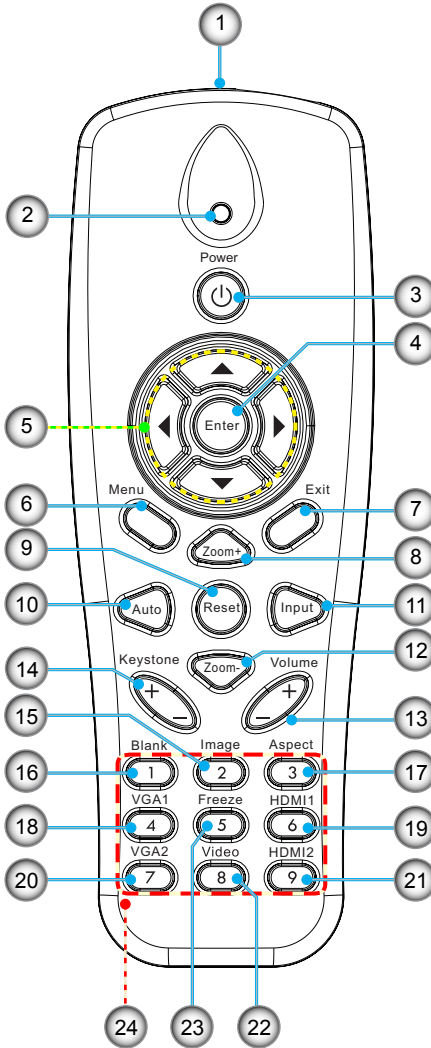

1. Infrared transmitter
2. LED Indicator
3. Power On/Off
4. OK
5. Four Directional Select Keys
6. Menu
7. Exit
8. Zoom in
9. Reset
10. Auto
11. Source
12. Zoom out
13. Volume +/-
14. Keystone +/-
15. Image
16. Black screen
17. Aspect ratio
18. VGA1
19. HDMI1
20. VGA2
21. HDMI2
22. Video
23. Screen freeze
24. Numbered keypad (for password input)



❖ Some keys may have not function for models which do not support these features.

Installation

Connecting the Projector Connect to Computer/Notebook

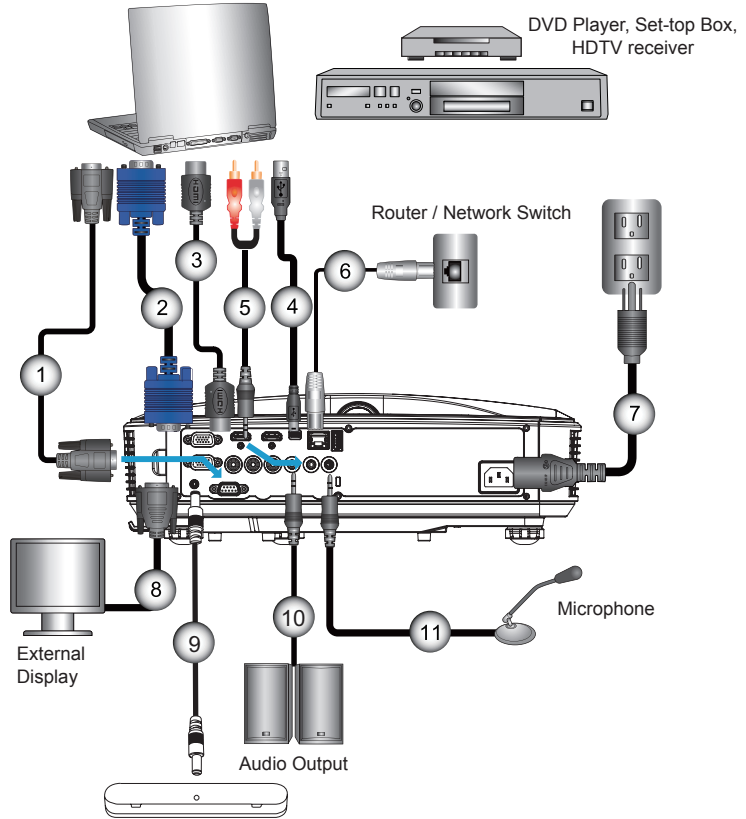

- ❖ Due to the difference in applications for each country, some regions may have different accessories.
- ❖ (*) Optional accessory

1.....	*RS232 Cable
2.....	VGA Cable
3.....	*HDMI Cable
4.....	*USB Cable
5.....	*Audio Cable/RCA
6.....	*RJ45 Cable
7.....	Power Cord
8.....	*VGA Output Cable
9.....	*Interactive Cable
10.....	*Audio Output Cable
11.....	*Microphone Input Cable

Installation

Connect to Video Sources

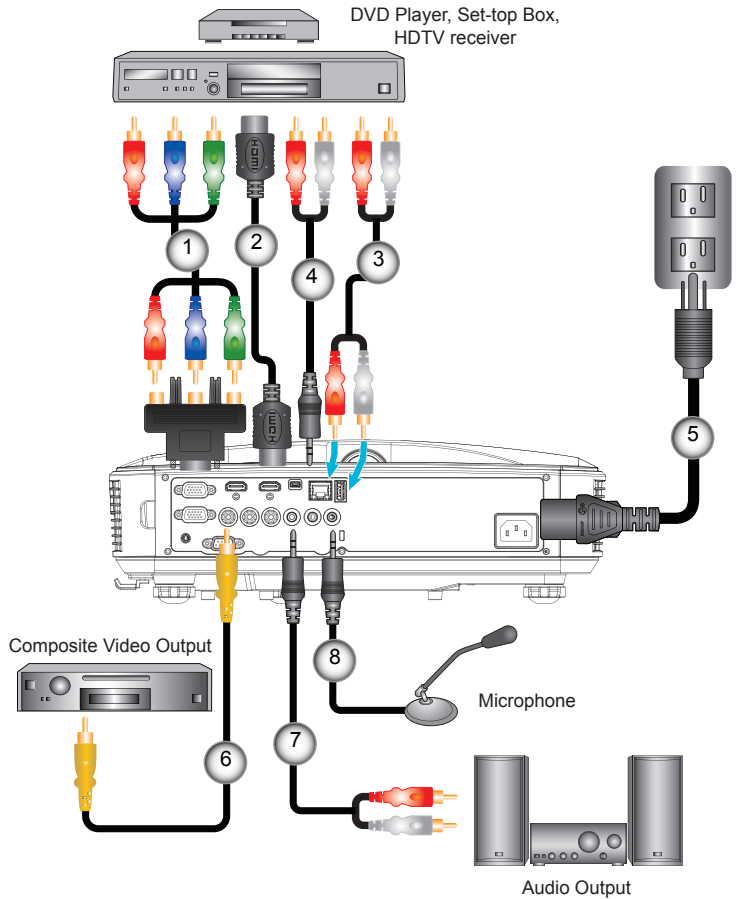

- ❖ Due to the difference in applications for each country, some regions may have different accessories.
- ❖ (*) Optional accessory

1.....	*15-Pin to 3 RCA Component/HDTV Adaptor
2.....	*HDMI Cable
3.....	*Audio Cable
4.....	*Audio Cable/RCA
5.....	Power Cord
6.....	*Composite Video Cable
7.....	*Audio Cable/RCA
8.....	*Audio Input Cable

Installation

Powering the Projector On / Off

Powering On the Projector

1. Securely connect the power cord and signal cable. When connected, the POWER/STANDBY LED will turn Orange.
2. Turn on the lamp by pressing “” button either on the projector or on the remote. At this moment, the POWER/STANDBY LED will now turn Blue. **1**

The startup screen will display in approximately 10 seconds. The first time you use the projector, you will be asked to select the preferred language and power saving mode.

3. Turn on and connect the source that you want to display on the screen (computer, notebook, video player, etc). The projector will detect the source automatically. If not, push menu button and go to “OPTIONS”.
Make sure that the “Source Lock” has been set to “Off”.

- ❖ If you connect multiple sources at the same time, press the “INPUT” button on the control panel or direct source keys on the remote control to switch between inputs.





❖ When the power mode is in standby mode (power consumption < 0.5W), the VGA output/ input and audio will be deactivated when the projector is in standby.

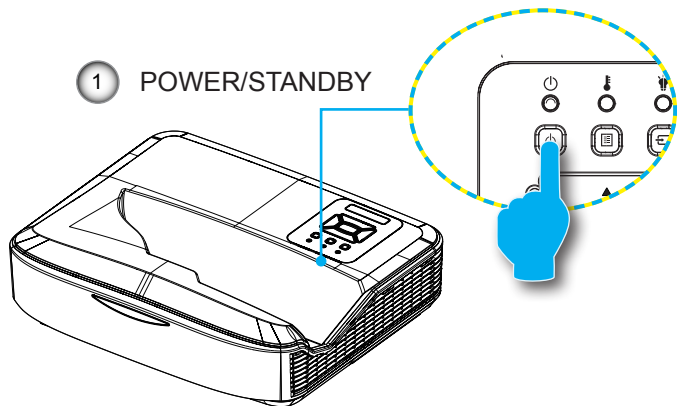

❖ Turn on the projector first and then select the signal sources.

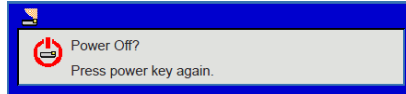

Powering Off the Projector

1. Press the “A screenshot of a projector's display screen showing a power off confirmation message. The message is displayed in a white box with a blue border. On the left side of the box is a red power button icon with a diagonal slash through it. To the right of the icon, the text reads: "Power Off?" followed by "Press power key again." on the next line.

Press the “

2. The cooling fans continue to operate for about 4 seconds for cooling cycle and the POWER/STANDBY LED will flash Orange. When the POWER/STANDBY LED lights solid Orange, the projector has entered standby mode.

If you wish to turn the projector back on, you must wait until the projector has completed the cooling cycle and has entered standby mode. Once in standby mode, simply press “

3. Disconnect the power cord from the electrical outlet and the projector.

Warning Indicator



❖ Contact the nearest service center if the projector displays these symptoms.

When the warning indicators (see below) come on, the projector will automatically shutdown:

- ❖ “LAMP” LED indicator is lit red and if “POWER/STANDBY” indicator flashes amber.
- ❖ “TEMP” LED indicator is lit red, this indicates the projector has overheated. Under normal conditions, the projector can be switched back on.
- ❖ “TEMP” LED indicator flashes red and if “POWER/STANDBY” indicator flashes amber.

Unplug the power cord from the projector, wait for 30 seconds and try again. If the warning indicator light up again, please contact your nearest service center for assistance.

Installation

Adjusting the Projected Image

Adjusting the Projector's Height

The projector is equipped with elevator feet for adjusting the image height.

1. Locate the adjustable foot you wish to modify on the underside of the projector.
2. Rotate the adjustable ring clockwise to raise the projector or counter clockwise to lower it. Repeat with the remaining feet as needed.

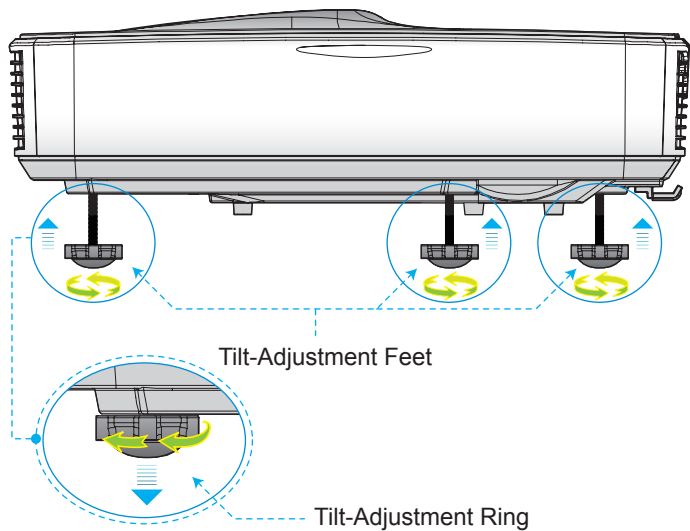

Installation

Adjusting the Projector's Focus

To focus the image, slide the focus switch to left/right until the image is clear.

- ▶ 1080p series: The projector will focus at distances (Lens to wall) from 1.654 to 2.205 feet (0.504 to 0.672 meters)
- ▶ WUXGA series: The projector will focus at distances (lens to wall) from 1.644 to 2.198 feet (0.501 to 0.670 meters)

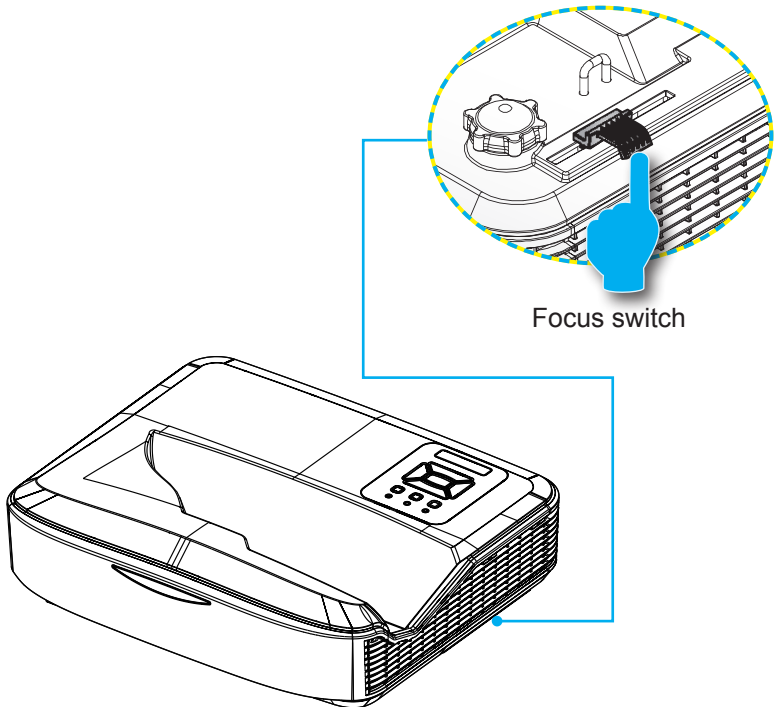

Installation

Adjusting Projection Image Size (Diagonal)

- ▶ 1080p series: Projection Image Size from 90" to 120" (2.286 to 3.048 meters)
- ▶ WUXGA series: Projection Image Size from 93" to 123" (2.362 to 3.124 meters)

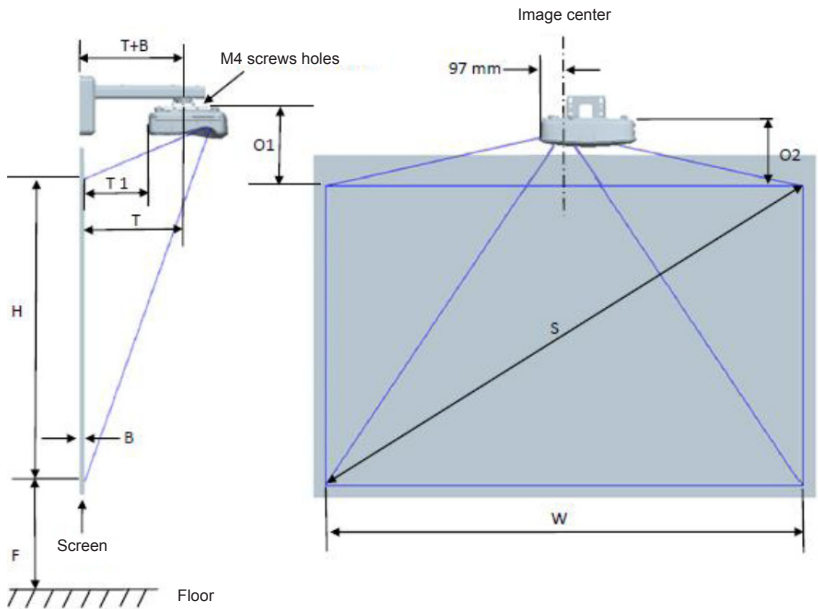

Installation

1080P (16:9) Wall mount installation measurement chart

Diagonal image size (S) in inch	Diagonal image size (S) in mm	Image width (W) in mm	Image height (H) in mm	Throw distance	Offset	Offset tolerance (+/-)	Distance from surface of whiteboard to center of projector mount (T) in mm	Distance from surface of whiteboard to back of projector (T1) in mm	Distance from top of image to top of wall plate (O) in mm	Distance from top of image to top of interface boss (O1) in mm	Distance from top of image to top of projector (O2) in mm
90	2286	1992	1121	504	224	34	379	242	363	287	267
91	2311	2015	1133	510	227	34	385	248	366	290	270
92	2337	2037	1146	515	229	34	390	253	368	292	272
93	2362	2059	1158	521	232	35	396	259	371	295	275
94	2388	2081	1171	527	234	35	402	265	373	297	277
95	2413	2103	1183	532	237	35	407	270	376	300	280
96	2438	2125	1196	538	239	36	413	276	378	302	282
97	2464	2147	1208	543	242	36	418	281	381	305	285
98	2489	2170	1220	549	244	37	424	287	383	307	287
99	2515	2192	1233	555	247	37	430	293	386	310	290
100	2540	2214	1245	560	249	37	435	298	388	312	292
101	2565	2236	1258	566	252	38	441	304	391	315	295
102	2591	2258	1270	571	254	38	446	309	393	317	297
103	2616	2280	1283	577	257	38	452	315	396	320	300
104	2642	2302	1295	583	259	39	458	321	398	322	302
105	2667	2325	1308	588	262	39	463	326	401	325	305
106	2692	2347	1320	594	264	40	469	332	403	327	307
107	2718	2369	1333	599	267	40	474	337	406	330	310
108	2743	2391	1345	605	269	40	480	343	408	332	312
109	2769	2413	1357	611	271	41	486	349	410	334	314
110	2794	2435	1370	616	274	41	491	354	413	337	317
111	2819	2457	1382	622	276	41	497	360	415	339	319
112	2845	2480	1395	627	279	42	502	365	418	342	322
113	2870	2502	1407	633	281	42	508	371	420	344	324
114	2896	2524	1420	639	284	43	514	377	423	347	327
115	2921	2546	1432	644	286	43	519	382	425	349	329
116	2946	2568	1445	650	289	43	525	388	428	352	332
117	2972	2590	1457	655	291	44	530	393	430	354	334
118	2997	2612	1470	661	294	44	536	399	433	357	337
119	3023	2634	1482	667	296	44	542	405	435	359	339
120	3048	2657	1494	672	299	45	547	410	438	362	342

Installation

WUXGA (16:10) Wall mount installation measurement chart											
Diagonal image size (S) in inch	Diagonal image size (S) in mm	Image width (W) in mm	Image height (H) in mm	Throw distance	Offset	Offset tolerance (+/-)	Distance from surface of whiteboard to center of projector mount (T) in mm	Distance from surface of whiteboard to back of projector (T1) in mm	Distance from top of image to top of wall plate (O) in mm	Distance from top of image to top of interface boss (O1) in mm	Distance from top of image to top of projector (O2) in mm
92	2337	1982	1239	501	211	37	376	239	350	274	254
93	2362	2003	1252	507	213	38	382	245	352	276	256
94	2388	2025	1265	512	215	38	387	250	354	278	258
95	2413	2046	1279	518	217	38	393	256	356	280	260
96	2438	2068	1292	523	220	39	398	261	359	283	263
97	2464	2089	1306	529	222	39	404	267	361	285	265
98	2489	2111	1319	534	224	40	409	272	363	287	267
99	2515	2132	1333	539	227	40	414	277	366	290	270
100	2540	2154	1346	545	229	40	420	283	368	292	272
101	2565	2175	1360	550	231	41	425	288	370	294	274
102	2591	2197	1373	556	233	41	431	294	372	296	276
103	2616	2219	1387	561	236	42	436	299	375	299	279
104	2642	2240	1400	567	238	42	442	305	377	301	281
105	2667	2262	1414	572	240	42	447	310	379	303	283
106	2692	2283	1427	578	243	43	453	316	382	306	286
107	2718	2305	1440	583	245	43	458	321	384	308	288
108	2743	2326	1454	589	247	44	464	327	386	310	290
109	2769	2348	1467	594	249	44	469	332	388	312	292
110	2794	2369	1481	599	252	44	474	337	391	315	295
111	2819	2391	1494	605	254	45	480	343	393	317	297
112	2845	2412	1508	610	256	45	485	348	395	319	299
113	2870	2434	1521	616	259	46	491	354	398	322	302
114	2896	2455	1535	621	261	46	496	359	400	324	304
115	2921	2477	1548	627	263	46	502	365	402	326	306
116	2946	2499	1562	632	265	47	507	370	404	328	308
117	2972	2520	1575	638	268	47	513	376	407	331	311
118	2997	2542	1589	643	270	48	518	381	409	333	313
119	3023	2563	1602	648	272	48	523	386	411	335	315
120	3048	2585	1615	654	275	48	529	392	414	338	318
121	3073	2606	1629	659	277	49	534	397	416	340	320
122	3099	2628	1642	665	279	49	540	403	418	342	322
123	3124	2649	1656	670	281	50	545	408	420	344	324
124	3150	2671	1669	676	284	50	551	414	423	347	327

❖ This table is for user's reference only.

Installation

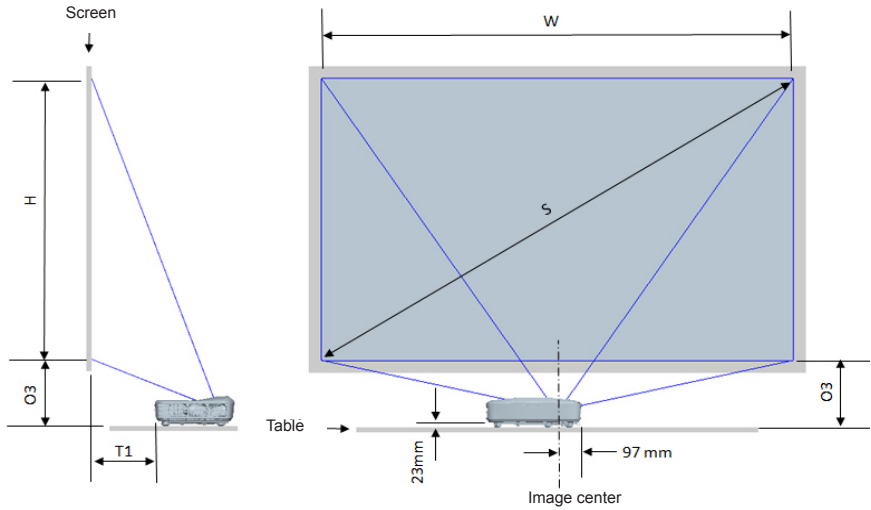

Installation

1080P (16:9) Table mount installation measurement chart					
Diagonal image size (S) in inch	Diagonal image size (S) in mm	Image width (W) in mm	Image height (H) in mm	Distance from surface of whiteboard to back of projector (T1) in mm	Distance from bottom of image to top of table (O3) in mm
90	2286	1992	1121	242	290
91	2311	2015	1133	248	293
92	2337	2037	1146	253	295
93	2362	2059	1158	259	298
94	2388	2081	1171	265	300
95	2413	2103	1183	270	303
96	2438	2125	1196	276	305
97	2464	2147	1208	281	308
98	2489	2170	1220	287	310
99	2515	2192	1233	293	313
100	2540	2214	1245	298	315
101	2565	2236	1258	304	318
102	2591	2258	1270	309	320
103	2616	2280	1283	315	323
104	2642	2302	1295	321	325
105	2667	2325	1308	326	328
106	2692	2347	1320	332	330
107	2718	2369	1333	337	333
108	2743	2391	1345	343	335
109	2769	2413	1357	349	337
110	2794	2435	1370	354	340
111	2819	2457	1382	360	342
112	2845	2480	1395	365	345
113	2870	2502	1407	371	347
114	2896	2524	1420	377	350
115	2921	2546	1432	382	352
116	2946	2568	1445	388	355
117	2972	2590	1457	393	357
118	2997	2612	1470	399	360
119	3023	2634	1482	405	362
120	3048	2657	1494	410	365

Installation

WUXGA (16:10) Table mount installation measurement chart

Diagonal image size (S) in inch	Diagonal image size (S) in mm	Image width (W) in mm	Image height (H) in mm	Distance from surface of whiteboard to back of projector (T1) in mm	Distance from bottom of image to top of table (O3) in mm
92	2337	1982	1239	239	277
93	2362	2003	1252	245	279
94	2388	2025	1265	250	281
95	2413	2046	1279	256	283
96	2438	2068	1292	261	286
97	2464	2089	1306	267	288
98	2489	2111	1319	272	290
99	2515	2132	1333	277	293
100	2540	2154	1346	283	295
101	2565	2175	1360	288	297
102	2591	2197	1373	294	299
103	2616	2219	1387	299	302
104	2642	2240	1400	305	304
105	2667	2262	1414	310	306
106	2692	2283	1427	316	309
107	2718	2305	1440	321	311
108	2743	2326	1454	327	313
109	2769	2348	1467	332	315
110	2794	2369	1481	337	318
111	2819	2391	1494	343	320
112	2845	2412	1508	348	322
113	2870	2434	1521	354	325
114	2896	2455	1535	359	327
115	2921	2477	1548	365	329
116	2946	2499	1562	370	331
117	2972	2520	1575	376	334
118	2997	2542	1589	381	336
119	3023	2563	1602	386	338
120	3048	2585	1615	392	341
121	3073	2606	1629	397	343
122	3099	2628	1642	403	345
123	3124	2649	1656	408	347
124	3150	2671	1669	414	350

User Controls

Control Panel & Remote Control

Control Panel

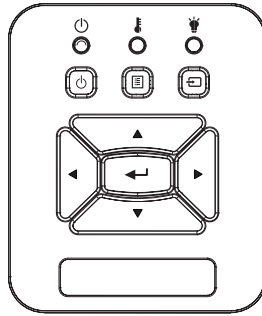

Using the Control Panel

POWER		Refer to the “Power On/Off the Projector” section on pages 14-15.
Enter		Press “Enter” to confirm your item selection.
INPUT		Press “INPUT” to select an input signal.
MENU		Press “MENU” to launch the on-screen display (OSD) menu. To exit OSD, press “MENU” again.
Four Directional Select Keys		Use ▲▼◀▶ to select items or make adjustments to your selection.
LAMP LED		Refer to the LED indicator of the projector light source status.
TEMP LED		Refer to the LED indicator of the projector temperature status.
ON/STANDBY LED		Refer to the LED indicator of the projector power status.

User Controls

Remote Control

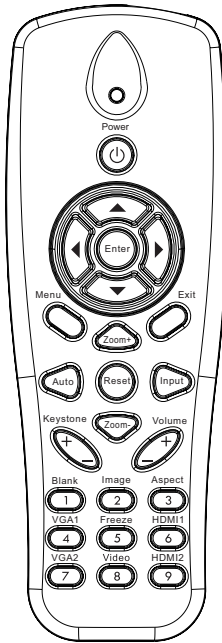

Using the Remote Control

Infrared transmitter	Sends signals to the projector.
LED	LED Indicator.
Power 	Refer to the “Power On/Off the Projector” section on pages 14-15.
Exit	Press “Exit” to close the OSD menu.
Zoom in	Zoom in the projector display.
Reset	Return the adjustments and settings to the factory default values. (except for lamp counter)
Zoom out	Zoom out the projector display.
Enter	Confirm your item selection.
Input	Press “Input” to select an input signal.
Auto	Automatically synchronizes the projector to the input source.
Four Directional Select Keys	Use ▲▼◀▶ to select items or make adjustments to your selection.
Keystone +/-	Adjust image distortion caused by tilting the projector.
Volume +/-	Adjust to increase / decrease the volume.
Aspect ratio	Use this function to choose your desired aspect ratio.
Menu	Press “Menu” to launch the on-screen display (OSD) menu. To exit OSD, press “Menu” again.

User Controls

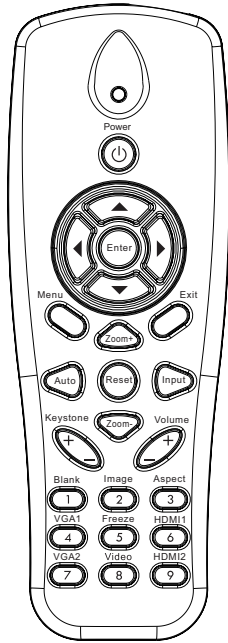

Using the Remote Control

VGA1	Press “VGA1” to choose VGA IN 1 connector.
Blank screen	Momentarily turns off/on the audio and video.
HDMI1	Press “HDMI1” to choose HDMI IN 1 connector.
HDMI2	Press “HDMI2” to choose HDMI IN 2 connector.
VGA2	Press “VGA2” to choose VGA IN 2 connector.
Video	Press “Video” to choose Composite video source.
Screen freeze	Pause the screen image. Press again to resume the screen image.
Image	Select the display mode from Bright, PC, Movie, Game, and User.

User Controls

IR Remote codes

key legend	NEC_CODE			
	Custom Code		Data	
	Byte1	Byte2	Byte3	Byte4
Power	FF	FF	E8	17
Up	FF	FF	E7	18
Left	FF	FF	E6	19
Enter	FF	FF	F8	7
Right	FF	FF	F7	8
Down	FF	FF	F6	9
Menu	FF	FF	EB	14
Zoom+	FF	FF	FB	4
Exit	FF	FF	FF	0
Auto	FF	FF	FA	5
Reset	FF	FF	EA	15
Input	FF	FF	E0	1F
Zoom-	FF	FF	FE	1
Keystone+	FF	FF	F0	0F
Keystone -	FF	FF	E2	1D
Volume-	FF	FF	F2	0D
Volume+	FF	FF	BD	42
Blank/1	FF	FF	BE	41
Image/2	FF	FF	F3	0C
Aspect/3	FF	FF	E3	1C
VGA1 /4	FF	FF	BF	40
Freeze/5	FF	FF	EC	13
HDMI1/6	FF	FF	E5	1A
VGA2 /7	FF	FF	E4	1B
HDMI2 /8	FF	FF	EF	10
S-Video /9	FF	FF	E1	1E

User Controls

On-screen Display Menus

The Projector has multilingual On-screen Display menus that allow you to make image adjustments and change a variety of settings.

Structure

Note: Please note that the on-screen display (OSD) menus vary according to the signal type selected and the projector model you are using.

Main Menu Tree 1st level	2nd level	3rd level	4th level	
Picture menu	Color mode	Bright / PC / Movie / Blending /Game / User		
	Wall Color	White/ Light yellow/ Light Blue/ Pink/ Dark Green		
	Brightness	Gauge for Adjust		
	Contrast	Gauge for Adjust		
	Sharpness	Gauge for Adjust		
	Saturation	Gauge for Adjust		
	Hue	Gauge for Adjust		
	Gamma	Gauge for Adjust		
	Color Temp	Gauge for Adjust(Number must display real color temp) 6500K/7500K/8300K		
	Color Setting	RGB		
Hue			Gauge for Adjust	
Saturation			Gauge for Adjust	
Gain			Gauge for Adjust	
Screen menu	Aspect Ratio	Auto / 4:3 / 16:9 / 16:10 (Ultra Wide 16:6)		
	Phase	Gauge for Adjust		
	Clock	Gauge for Adjust		
	H.Position	Gauge for Adjust		
	V.Position	Gauge for Adjust		
	Digital Zoom	Gauge for Adjust		
	Geometric Correction	V. Keystone		Gauge for Adjust
		H. Keystone		Gauge for Adjust
		4 Corner On/Off		On/Off
		Grid Color		White/Green/Red/Purple
		4 Corner Adjust		Pattern for adjust
	4 Corner Reset		Yes/No	
	Ceiling	Front / Front Ceiling / Rear / Rear Ceiling		
	Size	Gauge for Adjust		
Image Shift	Horizontal Position			
	Vertical Position			

User Controls

Main Menu Tree 1st level	2nd level	3rd level	4th level
Setting menu	Language	Submenu for 18 language 1 : English 2 : German 3 : Swedish 4 : French 5 : Arabic 6 : Dutch 7 : Norwegian 8 : Danish 9 : Simplified Chinese 10 : Polish 11 : Korean 12 : Russian 13 : Spanish 14 : Traditional Chinese 15 : Italian 16 : Portuguese 17 : Turkish 18 : Japanese	
	Menu Location	Left Top / Right Top / Center / Left Bottom / Right Bottom	
	Close Caption	Off / CC1 / CC2 / CC3 / CC4	
	VGA Out (Standby)	On/Off	
	VGA 2 (Function)	On/Off	
	LAN (Standby)	On/Off	
	Test Pattern	On/Off	
	Direct Power on	On/Off	
	Signal Power on	On/Off	
	Reset	Yes / No	
Volume Menu	Speaker	On/Off	
	Line out	On/Off	
	Microphone	On/Off	
	Mute	On/Off	
	Volume	Gauge for Adjust	
	Microphone Volume	Gauge for Adjust	

User Controls

Main Menu Tree 1st level	2nd level	3rd level	4th level	
Option Menu	Logo	Default / User		
	Logo Capture	Execute Screen Capture and display message on screen		
	Auto Source	On / Off		
	Input	VGA-1 / VGA-2 / HDMI-1 / HDMI-2 / Composite / Multimedia / LAN Display		
	Auto Power Off (min)	Gauge for Adjust		
	SSI Settings	SSI Hours Used (Normal)		
		SSI Hours Used (ECO)		
		SSI Power Mode		Normal / ECO
	High Attitude	On / Off		
	Filter	Filter Reminder		
	Remind(Hour)	Cleaning up reminder	Yes / No	
	Information	(Display only)	On / Off	
Projector ID	Gauge for Adjust			
Digital Signage	On/Off			
3D Menu	3D	Off / On /Auto		
	3D Invert	On / Off		
	3D Format	Frame Packing / Side-by-Side (Half) / Top and Bottom / Frame Sequential / Field Sequential		
	1080P@24	96Hz / 144Hz		
LAN Menu	Status	(Display only)		
	DHCP	On/Off		
	IP Address	Editable		
	Subnet Mask	Editable		
	Gateway	Editable		
	DNS	Editable		
	Store	Yes / No		
	MAC Address	(Display only)		
	Group Name	(Display only)		
	Projector Name	(Display only)		
	Location	(Display only)		
Contact	(Display only)			

User Controls

How to operate

1. To open the OSD menu, press “Menu” on the Remote Control or Projector Keypad.
2. When OSD is displayed, use the ▲▼ keys to select any item in the main menu. While making a selection on a particular page, press the ► or “Enter” key to enter sub menu.
3. Use the ▲▼ keys to select the desired item and adjust the settings using the ◀▶ key.
4. Select the next item to be adjusted in the sub menu and adjust as described above.
5. Press “Enter” to confirm, and the screen will return to the main menu.
6. To exit, press “Menu” again. The OSD menu will close and the projector will automatically save the new settings.

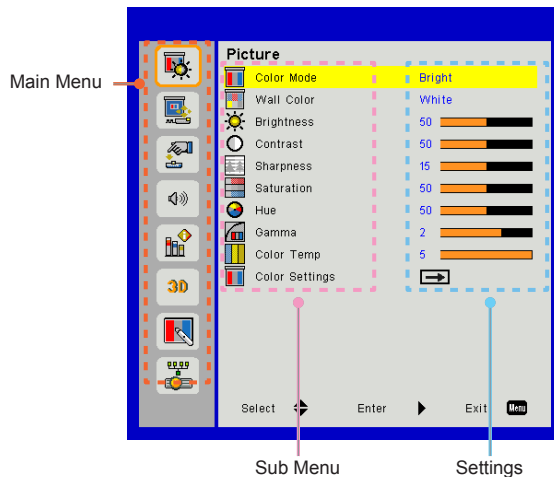

User Controls

Picture

Color Mode

There are many factory presets optimized for various types of images.

Use the ◀ or ▶ button to select the item.

- Bright: For brightness optimization.
- PC: For meeting presentation.
- Movie: For playing video content.
- Blending: Tone for stitching.
- Game: For game content.
- User: Memorize user's settings.

Wall Color

Use this function to obtain an optimized screen image according to the wall color. You can select from "White", "Light Yellow", "Light Blue", "Pink", and "Dark Green".

Brightness

Adjust the brightness of the image.

- Press the ◀ button to darken image.
- Press the ▶ button to brighten image.

Contrast

The Contrast controls the difference between the lightest and darkest parts of the picture. Adjusting the contrast changes the amount of black and white in the image.

- Press the ◀ button to decrease the contrast.
- Press the ▶ button to increase the contrast

User Controls

Sharpness

Adjust the sharpness of the image.

- Press the ◀ button to decrease the sharpness.
- Press the ▶ button to increase the sharpness.

Saturation

Adjust a video image from black and white to fully saturated color.

- Press the ◀ button to decrease the amount of saturation in the image.
- Press the ▶ button to increase the amount of saturation in the image.

Hue

Adjust the color balance of red and green.

- Press the ◀ button to increase the amount of green in the image.
- Press the ▶ button to increase the amount of red in the image.

Gamma

This allows you to adjust the gamma value to obtain the better image contrast for the input.

Color Temp

This allows you to adjust the color temperature. At higher temperature, the screen looks colder; at lower temperature, the screen looks warmer.

Color Setting

Use these settings for advanced adjustment of the individual Red, Green, Blue, Cyan, Magenta and Yellow Colors.

User Controls

Screen

Aspect Ratio

- Auto: Keep the image with original width-height ratio and maximize the image to fit native horizontal or vertical pixels.
- 4:3: The image will be scaled to fit the screen and displayed using a 4:3 ratio.
- 16:9: The image will be scaled to fit the width of the screen and the height adjusted to display the image using a 16:9 ratio.
- 16:10: The image will be scaled to fit the width of the screen and the height adjusted to display the image using a 16:10 ratio.

Phase

Synchronize the signal timing of the display with the graphic card. If the image appears to be unstable or flickers, use this function to correct it.

Clock

Adjust to achieve an optimal image when there is a vertical flicker in the image.

H.Position

- Press the ◀ button to move the image left.
- Press the ▶ button to move the image right.

V.Position

- Press the ◀ button to move the image down.
- Press the ▶ button to move the image up.

Digital Zoom

- Press the ◀ button to reduce the size of an image.
- Press the ▶ button to magnify an image on the projection screen.

Geometric Correction

- Use keystone or 4 corner adjustment features to get perfect, rectangular images.
- V. Keystone: Adjust image distortion vertically. If the image looks trapezoidal, this option can help make the image rectangular.
- H. Keystone: Adjust image distortion horizontally. If the image looks trapezoidal, this option can help make the image rectangular.
- 4 Corner On/Off: Select "On" to activate 4 corners correction functions.
- Grid Color: Set 4 corners correction function grid color.
- 4 Corner Adjust: Adjust the image 4 corners pixel by pixel to make the image rectangular.
- 4 Corner Reset: Return the factory default settings for H/V Keystone and 4 corners parameters.

Ceiling

- Front: The image is projected straight on the screen.
- Front Ceiling: This is the default selection. When selected, the image will turn upside down.
- Rear: When selected, the image will appear reversed.
- Rear Ceiling: When selected, the image will appear reversed in upside down position.

User Controls

Size

Press the right button and left button to adjust color bar and the value of number

Image Shift

Press the right button and left button to adjust color bar and the value of number

Setting

Language

Choose the multilingual OSD menu. Press the ◀ or ▶ button into the sub menu and then use the ▲ or ▼ button to select your preferred language. Press ▶ on the remote control to finalize the selection.

Menu Location

Choose the menu location on the display screen.

Close Caption

Use this function to enable close caption menu. Select an appropriate closed captions option: Off, CC1, CC2, CC3, and CC4.

VGA Out (Standby)

Choose “On” to enable VGA OUT connection.

VGA-2 (Function)

- Input: Choose “Input” to let the VGA port works as a VGA input function.
- Output: Choose “Output” to enable the VGA Out function once the projector is powered on.

LAN (Standby)

Choose “On” to enable LAN connection. Choose “Off” to disable LAN connection.

Test Pattern

Display a test pattern.

User Controls

Direct Power On

Select the “On” to activate Direct Power mode. The projector will automatically power on when AC power is supplied, without pressing the “Power” key on the projector keypad or on the remote control.

Signal Power On

Select the “On” to activate Signal Power mode. The projector will automatically power on when a signal is detected, without pressing the “Power” key on the projector Keypad or on the remote control.

Reset

Choose “Yes” to return the parameters on all menus to the factory default settings.

Volume

Speaker

- Choose “On” to enable the speaker.
- Choose “Off” to disable the speaker.

Line out

- Choose “On” to enable the line out function.
- Choose “Off” to disable the line out function.

Microphone

- Choose “On” to enable the microphone.
- Choose “Off” to disable the microphone.

Mute

- Choose “On” to turn mute on.
- Choose “Off” to turn mute off.

Volume

- Press the ◀ button to decrease the volume.
- Press the ▶ button to increase the volume.

Microphone Volume

- Press the ◀ button to decrease the microphone volume.
- Press the ▶ button to increase the microphone volume.

User Controls

Option

Logo

Use this function to set the desired startup screen. If changes are made they will take effect the next time the projector is powered on.

- Default: The default startup screen.
- User: Use stored picture from “Logo Capture” function.

Logo Capture

Press ► button to capture an image of the picture currently displayed on screen.

Auto Source

- On: The projector will search for other signals if the current input signal is lost.
- Off: The projector will only search current input connection.

Input

Press ► button to enable/disable input sources. The projector will not search for inputs that are not selected.

Auto Power Off (Min)

Sets the countdown timer interval. The countdown timer will start, when there is no signal being sent to the projector. The projector will automatically power off when the countdown has finished (in minutes).

User Controls

SSI Settings

- SSI Hours Used(Normal):Display the projection time of normal mode.
- SSI Hours Used(ECO):Display the projection time of ECO mode.
- Press enter to Power Mode.

High Altitude

- On: The built-in fans run at high speed. Select this option when using the projector at altitudes above 2500 feet/762 meters or higher.
- Off: The built-in fans automatically run at a variable speed according to the internal temperature.

Filter Remind (Hour)

- Filters Remind (Hour): Set the filter reminder time.
- Cleaning Up Remind: Select “Yes” to reset the dust filter hour counter after replacing or cleaning the dust filter.

Information

Display the projector information for model name, SNID, source, resolution, software version, and aspect ratio on the screen.

Projector ID

ID definition can be set up by menu (range 00-99), and allow use control an individual projector by using RS232 command.

User Controls

Digital Signage

- It's an auto playback function for media.
- Create a folder named "signage" in your USB and insert into USB port.
- Choose "On" and restart to active the function to play the files in your signage folder automatically.
- Choose "Off" to disable the function.

3D

3D

- Auto: When a HDMI 1.4a 3D timing identification signal is detected, the 3D image is selected automatically.
- Choose “On” to enable 3D function.
- Choose “Auto” to detected 3D signal automatically.

3D Invert

If you see a discrete or overlapping image while wearing DLP 3D glasses, you may need to execute “Invert” to get best match of left/ right image sequence to get the correct image.

3D Format

Use this feature to select the 3D format. Options are: “Frame Packing”, “Side-by-Side (Half)”, “Top and Bottom”, “Frame Sequential”, and “Field Sequential”.

1080p@24

Use this feature to select 96 or 144Hz refresh rate as using 3D glasses in the 1080p @ 24 frame packing.

User Controls

LAN

Status

Display the network connection status.

DHCP

Configure the DHCP settings.

- On: Choose “On” to let the projector to obtain an IP address automatically from your network.
- Off: Choose “Off” to assign IP, Subnet Mask, Gateway, and DNS configuration manually.

IP Address

Display an IP address.

Subnet Mask

Display the subnet mask number.

Gateway

Display the default gateway of the network connected to the projector.

DNS

Display the DNS number.

Store

Select the “Yes” to save the changes made in network configuration settings.

MAC Address

Display the MAC address.

User Controls

Group Name

Display the group name.

Projector Name

Display the projector name

Location

Display the projector location.

Contact

Display the contact information.

User Controls

How to use web browser to control your projector

1. Turn on DHCP to allow a DHCP server to automatically assign an IP, or manually enter the required network information.

Status	Connect
DHCP	Off
IP Address	172.16.1.42
Subnet Mask	255.255.255.0
Gateway	172.16.1.254
DNS	172.16.1.1

2. Then choose apply and press **OK** button to complete the configuration process.

3. Open your web browser and type in IP Address from the OSD LAN screen then the web page will display as below:



4. Based on network web-page for the input-string in [tools] tab, the limitation for Input-Length is in the below list ("space" and the other punctuation key included):

Category	Item	Input-Length (characters)
Crestron Control	IP Address	15
	IP ID	2
	Port	5
Projector	Projector Name	10
	Location	9
	Assigned To	9
Network Configuration	DHCP (Enabled)	(N/A)
	IP Address	15
	Subnet Mask	15
	Default Gateway	15
	DNS Server	15
User Password	Enabled	(N/A)
	New Password	15
	Confirm	15
Admin Password	Enabled	(N/A)
	New Password	15
	Confirm	15



❖ When you used the projector IP address, you will can not link to your service server.

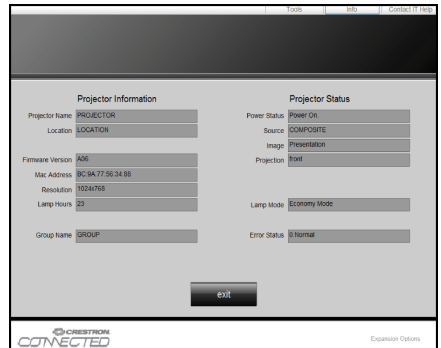

User Controls

When making a direct connection from your computer to the projector

Step 1: Find an IP Address (192.168.0.100) from LAN function of projector.



Step 2: Select apply and press “Enter” button to submit function or press “menu” key to exit.

Step 3: To open Network Connections, click **Start**, click **Control Panel**, click **Network and Internet Connections**, and then click **Network Connections**. Click the connection you want to configure, and then, under **Network Tasks** , click **Change settings of this connection**.

Step 4: On the **General** tab, under **This connection uses the following items**, click **Internet Protocol (TCP/IP)**, and then click “Properties.”

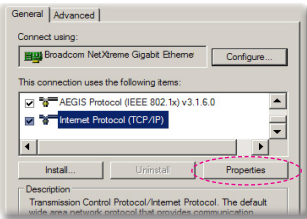

Step 5: Click **Use the following IP address**, and type in as below:

- 1) IP address: 192.168.0.100
- 2) Subnet mask: 255.255.255.0
- 3) Default gateway: 192.168.0.254

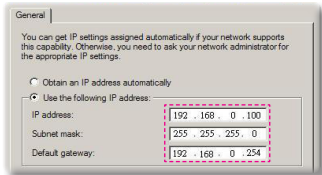

Step 6: To open Internet Options, click IE web browser, click Internet Options, click the **Connections** tab and click “LAN Settings...”

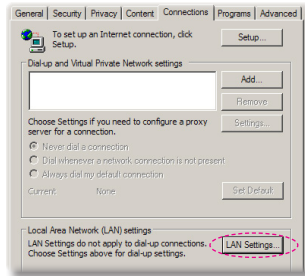

Step 7: The **Local Area Network (LAN) Setting** dialog box appears. In the **Proxy Server** area, cancel the **Use a proxy server for your LAN** check box, then click “OK” button twice.

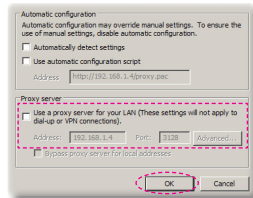

Step 8: Open your IE and type in the IP address of 192.168.0.100 in the URL then press “Enter” key.

User Controls

Crestron RoomView Control Tool

Crestron RoomView™ provides a central monitoring station for 250+ control systems on a single Ethernet network (more are possible, the number depends on the combination of IP ID and IP address). Crestron RoomView monitors each projector, including projector's online status, system power, lamp life, network setting and hardware faults, plus any custom attribute as defined by the Administrator. The Administrator can add, delete, or edit room information, contact information and events, which are logged automatically by the software for all users. (Operation UI as following image)

1. Main Screen

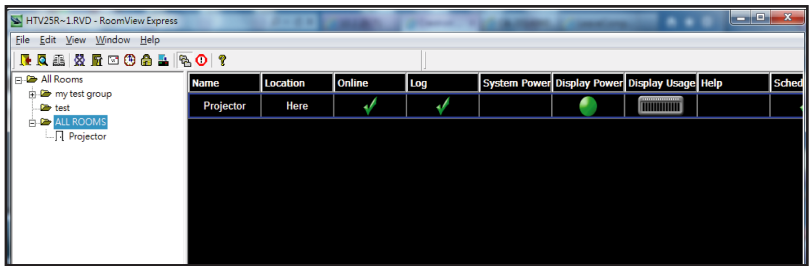

2. Edit Room



- ❖ Crestron RoomView's function is set according to the products' models and specifications.

Room Information

Name: crestron room Phone: _____

Location: _____ e-Control Link: _____ Browse...

IP Address: 192.168.0.101 Video Link: _____

IPID/IP Port: 03 | 41794

DHCP Enabled SSL

External Gateway Username: _____

0.0.0.0 Password: _____

Comment

Save Room Save As Help

OK Cancel Apply

User Controls

3. Edit Attribute

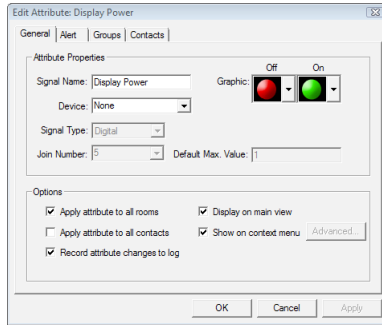

4. Edit Event

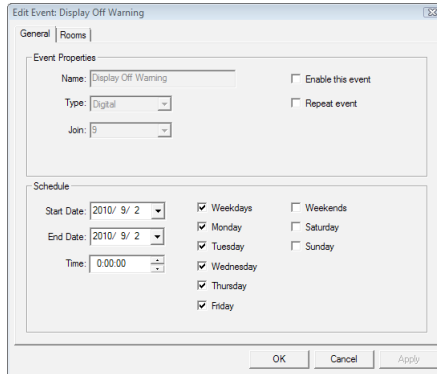

For further information, please visit:

<http://www.crestron.com> & www.crestron.com/getroomview.

Appendices

Installing and Cleaning the Optional Dust Filter

We recommend you clean the dust filter every 500 hours of operation, or more often if you are using the projector in a dusty environment.

When the warning message appears on the screen, do the following to clean the air filter:

The usage time of the dust filter is reached.
Please clean the dust filters for better performance.



- ❖ The optional dust filter should be used in dusty environments.
- ❖ If the dust filter is installed, a proper maintenance will prevent overheating and projector malfunction.
- ❖ The dust filter is optional.
- ❖ The specific interfaces are selected in terms of the specifications of types.

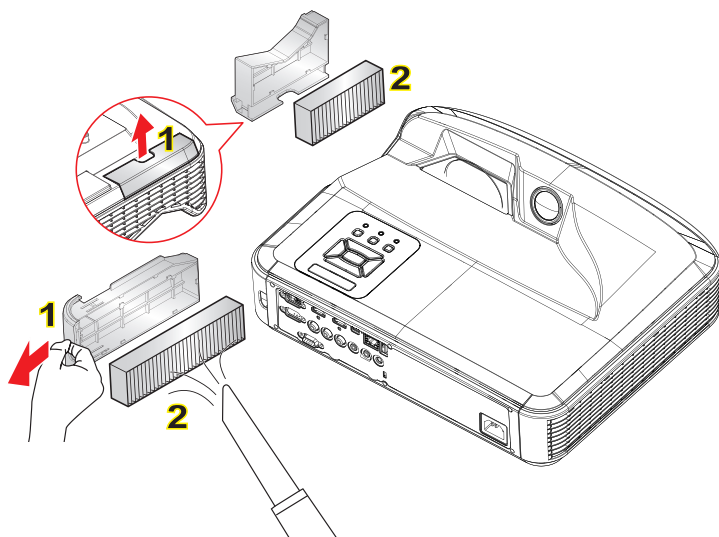

○ Air Filter Cleaning Procedure: ○

1. Switch off the power to the projector by pressing the “**⏻**” button.
 2. Disconnect the power cord.
 3. Pull out the dust filter, as shown in the illustration. **1**
 4. Carefully remove the dust filter. Then clean or change the filter. **2**
- To install the filter, reverse the previous steps.
5. Turn on the projector and reset the filter usage counter after the dust filter is replaced.

Compatibility Modes

▶ VGA Analog

a. PC signal			
Modes	Resolution	V. Frequency [Hz]	H. Frequency [Hz]
VGA	640x480	60	31.5
	640x480	67	35.0
	640x480	72	37.9
	640x480	75	37.5
	640x480	85	43.3
	640x480	120	61.9
IBM	720x400	70	31.5
SVGA	800x600	56	35.1
	800x600	60	37.9
	800x600	72	48.1
	800x600	75	46.9
	800x600	85	53.7
	800x600	120	77.4
Apple, MAC II	832x624	75	49.1
XGA	1024x768	60	48.4
	1024x768	70	56.5
	1024x768	75	60.0
	1024x768	85	68.7
	1024x768	120	99.0
Apple, MAC II	1152x870	75	68.7
SXGA	1280x1024	60	64.0
	1280x1024	72	77.0
	1280x1024	75	80.0
QuadVGA	1280x960	60	60.0
	1280x960	75	75.2
SXGA+	1400x1050	60	65.3
UXGA	1600x1200	60	75.0

Appendices

b. Extended wide timing			
Modes	Resolution	V. Frequency [Hz]	H. Frequency [Hz]
WUXGA	1920x1200	60	74
WXGA	1280x720	60	44.8
	1280x800	60	49.6
	1366x768	60	47.7
	1440x900	60	59.9
WSXGA+	1680x1050	60	65.3
c. Component signal			
Modes	Resolution	V. Frequency [Hz]	H. Frequency [Hz]
480i	720x480 (1440x480)	59.94(29.97)	15.7
576i	720x576 (1440x576)	50(25)	15.6
480p	720x480	59.94	31.5
576p	720x576	50	31.3
720p	1280x720	60	45.0
	1280x720	50	37.5
1080i	1920x1080	60(30)	33.8
	1920x1080	50(25)	28.1
1080p	1920x1080	23.98/24	27.0
	1920x1080	60	67.5
	1920x1080	50	56.3

Appendices

▶ HDMI Digital

a. PC signal			
Modes	Resolution	V. Frequency [Hz]	H. Frequency [Hz]
VGA	640x480	60	31.5
	640x480	67	35.0
	640x480	72	37.9
	640x480	75	37.5
	640x480	85	43.3
	640x480	120	61.9
IBM	720x400	70	31.5
SVGA	800x600	56	35.1
	800x600	60	37.9
	800x600	72	48.1
	800x600	75	46.9
	800x600	85	53.7
	800x600	120	77.4
Apple, MAC II	832x624	75	49.1
XGA	1024x768	60	48.4
	1024x768	70	56.5
	1024x768	75	60.0
	1024x768	85	68.7
	1024x768	120	99.0
Apple, MAC II	1152x870	75	68.7
SXGA	1280x1024	60	64.0
	1280x1024	72	77.0
	1280x1024	75	80.0
QuadVGA	1280x960	60	60.0
	1280x960	75	75.2
SXGA+	1400x1050	60	65.3
UXGA	1600x1200	60	75.0

Appendices

b. Extended wide timing			
Modes	Resolution	V. Frequency [Hz]	H. Frequency [Hz]
WUXGA	1920x1200	60	74
WXGA	1280x720	60	44.8
	1280x800	60	49.6
	1366x768	60	47.7
	1440x900	60	59.9
WSXGA+	1680x1050	60	65.3
c. Video signal			
Modes	Resolution	V. Frequency [Hz]	H. Frequency [Hz]
480p	640x480	59.94/60	31.5
480i	720x480 (1440x480)	59.94(29.97)	15.7
576i	720x576 (1440x576)	50(25)	15.6
480p	720x480	59.94	31.5
576p	720x576	50	31.3
720p	1280x720	60	45.0
	1280x720	50	37.5
1080i	1920x1080	60(30)	33.8
	1920x1080	50(25)	28.1
1080p	1920x1080	23.98/24	27.0
	1920x1080	60	67.5
	1920x1080	50	56.3
d. HDMI 1.4a mandatory 3D timing- Video Signal			
Modes	Resolution	V. Frequency [Hz]	H. Frequency [Hz]
Frame Packing	720p	50	31.5
	720p	59.94/60	15.7
	1080p	23.98/24	15.6
Side-by-Side (Half)	1080i	50	31.5
	1080i	59.94/60	31.3
Top and Bottom	720p	50	45.0
	720p	59.94/60	37.5
	1080p	23.98/24	33.8

Regulation & Safety Notices

This appendix lists the general notices of your projector.

FCC notice

This device has been tested and found to comply with the limits for a Class B digital device pursuant to Part 15 of the FCC rules. These limits are designed to provide reasonable protection against harmful interference in a residential installation. This device generates, uses and can radiate radio frequency energy and, if not installed and used in accordance with the instructions, may cause harmful interference to radio communications.

However, there is no guarantee that interference will not occur in a particular installation. If this device does cause harmful interference to radio or television reception, which can be determined by turning the device off and on, the user is encouraged to try to correct the interference by one or more of the following measures:

- Reorient or relocate the receiving antenna.
- Increase the separation between the device and receiver.
- Connect the device into an outlet on a circuit different from that to which the receiver is connected.
- Consult the dealer or an experienced radio/television technician for help.

Notice: Shielded cables

All connections to other computing devices must be made using shielded cables to maintain compliance with FCC regulations.

Caution

Changes or modifications not expressly approved by the manufacturer could void the user's authority, which is granted by the Federal Communications Commission, to operate this projector.

Appendices

Operation conditions

This device complies with Part 15 of the FCC Rules. Operation is subject to the following two conditions:

1. This device may not cause harmful interference and
2. This device must accept any interference received, including interference that may cause undesired operation.

Notice: Canadian users

This Class B digital apparatus complies with Canadian ICES-003.

Remarque à l'intention des utilisateurs canadiens

Cet appareil numérique de la classe B est conforme à la norme NMB-003 du Canada.

Declaration of Conformity for EU countries

- EMC Directive 2004/108/EC (including amendments)
- Low Voltage Directive 2006/95/EC
- R & TTE Directive 1999/5/EC (if product has RF function)

Disposal instructions



Do not throw this electronic device into the trash when discarding. To minimize pollution and ensure utmost protection of the global environment, please recycle it.

Ceiling Mount Installation

1. To prevent damage to your projector, please use the Optoma ceiling mount.
2. If you wish to use a third party ceiling mount kit, please ensure the screws used to attach a mount to the projector meet the following specifications:
 - ▶ Screw type: M4*3
 - ▶ Minimum screw length: 10mm



❖ Please note that damage resulting from incorrect installation will void the warranty.



⚠ Warning:

1. If you buy a ceiling mount from another company, please be sure to use the correct screw size. Screw size will vary depending on the thickness of the mounting plate.
2. Be sure to keep at least 10 cm gap between the ceiling and the bottom of the projector.
3. Avoid installing the projector near a heat source.

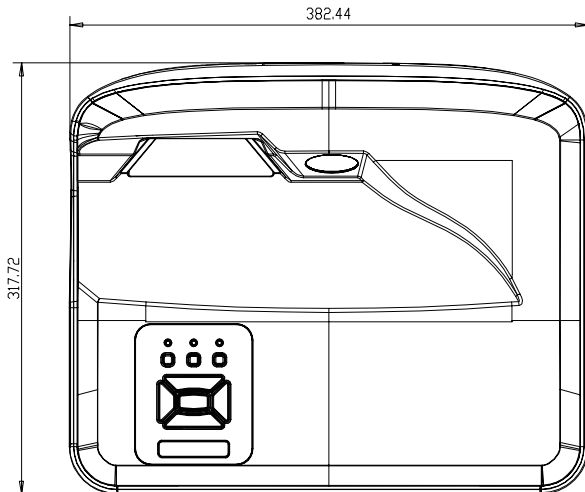
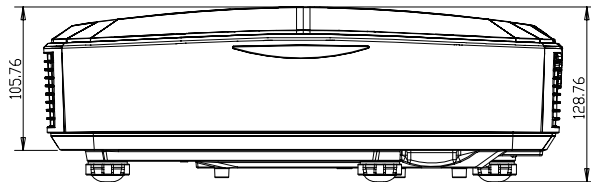



Appendices

Optoma global offices

For service or support, please contact your local office.



USA

47697 Westinghouse Drive
Fremont, CA 94539, USA
www.optomausa.com

 888-289-6786
 510-897-8601
 services@optoma.com



Canada

47697 Westinghouse Drive
Fremont, CA 94539, USA
www.optomausa.com

 888-289-6786
 510-897-8601
 services@optoma.com

Latin America

47697 Westinghouse Drive
Fremont, CA 94539, USA
www.optomausa.com

 888-289-6786
 510-897-8601
 services@optoma.com



Europe

Unit 1, Network 41, Bourne End Mills
Hemel Hempstead, Herts
HP1 2UJ, United Kingdom
www.optoma.eu
Service Tel : +44 (0)1923 691865

 +44 (0) 1923 691 800
 +44 (0) 1923 691 888
 service@tsc-europe.com

Benelux BV

Randstad 22-123
1316 BW Almere
The Netherlands
www.optoma.nl

 +31 (0) 36 820 0252
 +31 (0) 36 548 9052

France

Bâtiment E
81-83 avenue Edouard Vaillant
92100 Boulogne Billancourt,
France

 +33 1 41 46 12 20
 +33 1 41 46 94 35
 savoptoma@optoma.fr



Spain

C/ José Hierro,36 Of. 1C
28522 Rivas VaciaMadrid,
Spain

 +34 91 499 06 06
 +34 91 670 08 32



Deutschland

Wiesenstrasse 21 W
D40549 Düsseldorf,
Germany

 +49 (0) 211 506 6670
 +49 (0) 211 506 66799
 info@optoma.de

Scandinavia



Lerpeveien 25
3040 Drammen
Norway

 +47 32 98 89 90
 +47 32 98 89 99
 info@optoma.no

PO.BOX 9515
3038 Drammen
Norway

Korea

WOOMI TECH.CO.,LTD.
4F.Minu Bldg.33-14, Kangnam-Ku,
seoul,135-815, KOREA

 +82+2+34430004
 +82+2+34430005

Japan

東京都足立区綾瀬3-25-18



株式会社オーエス

コンタクトセンター:0120-380-495

 info@os-worldwide.com
www.os-worldwide.com



Taiwan

12F., No.213,Sec. 3, Beixin Rd.,
Xindian Dist., New Taipei City 231,
Taiwan, R.O.C.
www.optoma.com.tw

 +886-2-8911-8600
 +886-2-8911-6550
 services@optoma.com.tw
asia.optoma.com



Hong Kong

Unit A, 27/F Dragon Centre,
79 Wing Hong Street,
Cheung Sha Wan,
Kowloon, Hong Kong

 +852-2396-8968
 +852-2370-1222
www.optoma.com.hk

China

5F, No. 1205, Kaixuan Rd.,
Changning District
Shanghai, 200052, China

 +86-21-62947376
 +86-21-62947375
www.optoma.com.cn

